

2014



EDS TECHNOLOGIES



The year 2013 has been a very fulfilling year for all of us at EDST. In spite of very difficult economic conditions we grew our business significantly by bringing in value to many of our customers and help them also grow in their business. We have also increased our product portfolio to now include Enterprise applications as well. Our goal is to be a one stop solution company and ensure that our

customers can rely on us to provide total solution for their enterprise need. With this goal in mind we have increased our product, service and training offering significantly and we hope to add more to this as we understand our customers requirement on a continuous basis. Please take time to visit our new look website www.edstechnologies.com to understand our entire suite of offerings. We thank all our customer for their business in 2013 and we look forward to working closely with you in addressing your business needs in the coming years. Wish you all very Happy and prosperous 2014.

S. Senthil

President, EDS Technologies Pvt. Ltd.

An Integrated Approach to PLM and Real Time Visual Simulation

MILESTONES ACHIEVED IN 2013

- ▶ EDS Technologies receives "VAR OF THE YEAR" Award from Dassault Systemes for exceeding sales target.
- ▶ EDS Technologies receives "Achievement Award – Honorable Mention" from VT MAK, A company of VT Systems.
- ▶ EDS Technologies partnered as official Authorised Training Centre (ATC) with Autodesk, Inc. for training services in India.
- ▶ EDS Technologies and Dassault Systemes jointly conducted "3D Experience seminars" across the country.
- ▶ EDS Technologies partnered with SAP for providing enterprise solutions to its customers.
- ▶ As a part of CSR, EDST organized Industry Academia Interaction meet across multiple cities in INDIA.
- ▶ EDS Technologies has achieved a significant milestone by training more than 7000 students in CAD/CAM/CAE technology.
- ▶ EDS Technologies expands reach to its customers with new office in Kochi as part of business expansion in India.

INNOVATION | TECHNOLOGY | QUALITY | TIMELINESS



Services

EDST services is focused to provide technical support and services to the customers and thereby adding more value to their core business. EDST service offerings includes onsite PLM related services like Engineering Design Support, Technical Support, Administration, PLM Installation, Implementation, Peak Load Management and Staffing Consultants.

Help Desk Support

- Online telephonic support
- Issue resolution
- Onsite engineers
- Escalation to L2
- Call tracking and monitoring
- Maintain Knowledge database
- Report generation
- User feedback

L1 & L2 Support

- Onsite technical support
- CAD & PLM Administration support
- Issue resolution
- Escalation to L3
- CRISIT issue resolution
- OEM coordination

PLM Implementation Support

- Installation & configuration
- Customized (OEM) installation & configuration
- Customization support
- Database maintenance
- License management
- Integration services

Start-Up Services

- System Integration
- Vendor Management
- IT Management
- Design house management
- Staffing solutions

Training Division

In continuation to our efforts to provide a complete eco-system to PLM market space, we provide comprehensive training programs on DS, Autodesk and Altair range of solutions which includes CATIA, ABAQUS, ENOVIA, DELMIA, AutoCAD, Inventor, Revit and HyperWorks. EDST is the Certified Education Partner to Dassault Systemes, Authorized Training Centre for Autodesk and Authorized Competency Centre for Altair HyperWorks. All the trainings are provided by our certified instructors and delivered through the proven methodologies used worldwide.

We Offer:

- Skill Assessment and Customized Training
- Talent building through tie-up with leading technical institutions
- Pre-hiring services
- Performance Accelerator Program for corporate
- Placement and Internship assistance

Customized Training offerings from EDS Technologies includes:

- | | |
|--|--|
| CATIA Composite Design | CATIA Engine Design Methodology |
| CATIA 3D Tolerancing & Annotation | CATIA Automotive Body-In-White Fastening |
| CATIA Knowledge Based Engineering | CATIA V5 to V6 Transition |
| CATIA Tubing & Piping Design | ENOVIA V5 VPM- User & Administration |
| CATIA Digital Mock-up & Fitting Simulation | ENOVIA Program Central, Engineering Central, Library Central |
| CATIA Electrical Wire Harness | HyperMesh and Radioss |
| CATIA Foundation for Aerospace Designers | AutoCAD |
| CATIA Aerospace Sheetmetal Design | Inventor |
| CATIA Automotive Fundamentals for Body, Chassis & Powertrain Designers | Revit Mep |
| | Revit Architecture |
| | 3DS Max Design |

Strategic Partners



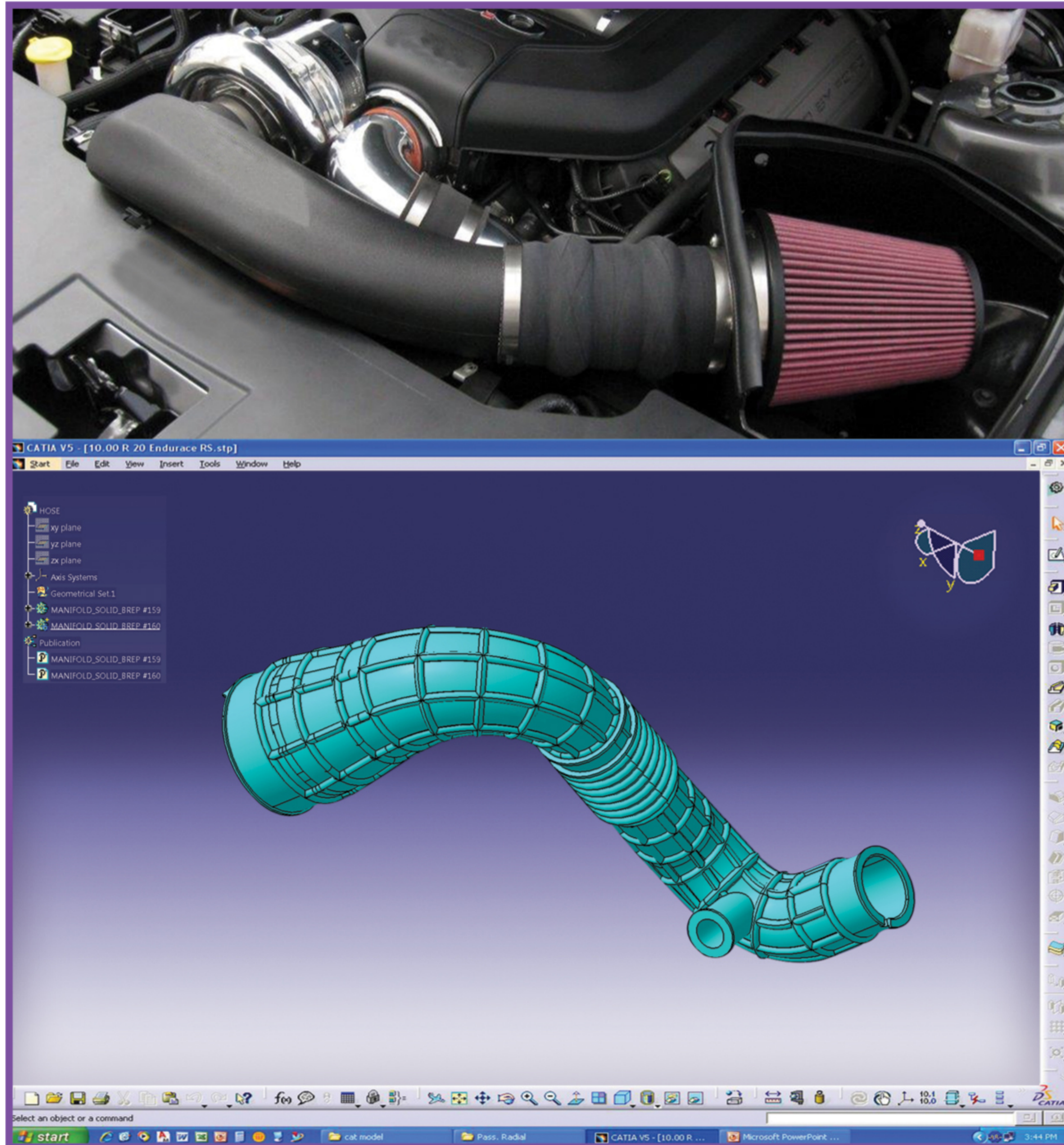

“CATIA-V5 enables user to work with ease to design complex shapes faster.”

Bony Polymers(P) Ltd

January 2014

WEEK	M	T	W	T	F	S	S
1			1	2	3	4	5
2	6	7	8	9	10	11	12
3	13	14	15	16	17	18	19
4	20	21	22	23	24	25	26
5	27	28	29	30	31		

December						
M	T	W	T	F	S	S
30	31					1
2	3	4	5	6	7	8
9	10	11	12	13	14	15
16	17	18	19	20	21	22
23	24	25	26	27	28	29

February						
M	T	W	T	F	S	S
					1	2
3	4	5	6	7	8	9
10	11	12	13	14	15	16
17	18	19	20	21	22	23
24	25	26	27	28		

February 2014



WEEK	M	T	W	T	F	S	S
5						1	2
6	3	4	5	6	7	8	9
7	10	11	12	13	14	15	16
8	17	18	19	20	21	22	23
9	24	25	26	27	28		

January						
M	T	W	T	F	S	S
		1	2	3	4	5
6	7	8	9	10	11	12
13	14	15	16	17	18	19
20	21	22	23	24	25	26
27	28	29	30	31		

March						
M	T	W	T	F	S	S
31					1	2
3	4	5	6	7	8	9
10	11	12	13	14	15	16
17	18	19	20	21	22	23
24	25	26	27	28	29	30

"Presagis tools being effectively used to develop re-usable open flight database for high fidelity visual system."

March 2014

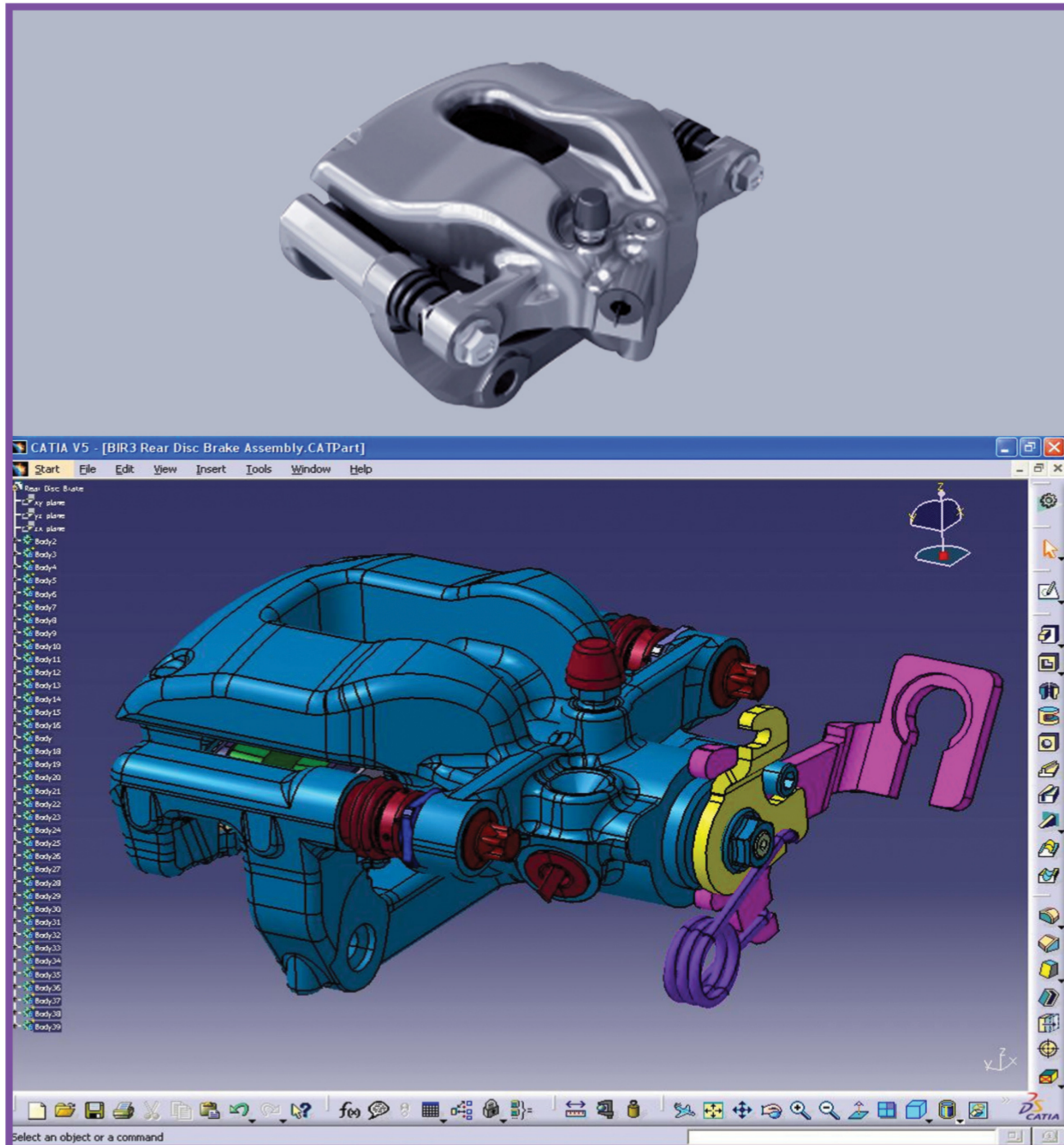

WEEK	M	T	W	T	F	S	S
9	31					1	2
10	3	4	5	6	7	8	9
11	10	11	12	13	14	15	16
12	17	18	19	20	21	22	23
13	24	25	26	27	28	29	30

February						
M	T	W	T	F	S	S
					1	2
3	4	5	6	7	8	9
10	11	12	13	14	15	16
17	18	19	20	21	22	23
24	25	26	27	28		

April						
M	T	W	T	F	S	S
	1	2	3	4	5	6
7	8	9	10	11	12	13
14	15	16	17	18	19	20
21	22	23	24	25	26	27
28	29	30				

“With the help of CATIA, we were able to reduce design cycle time and deliver products much faster than our competitors do.”

Chassis Brakes International

April 2014

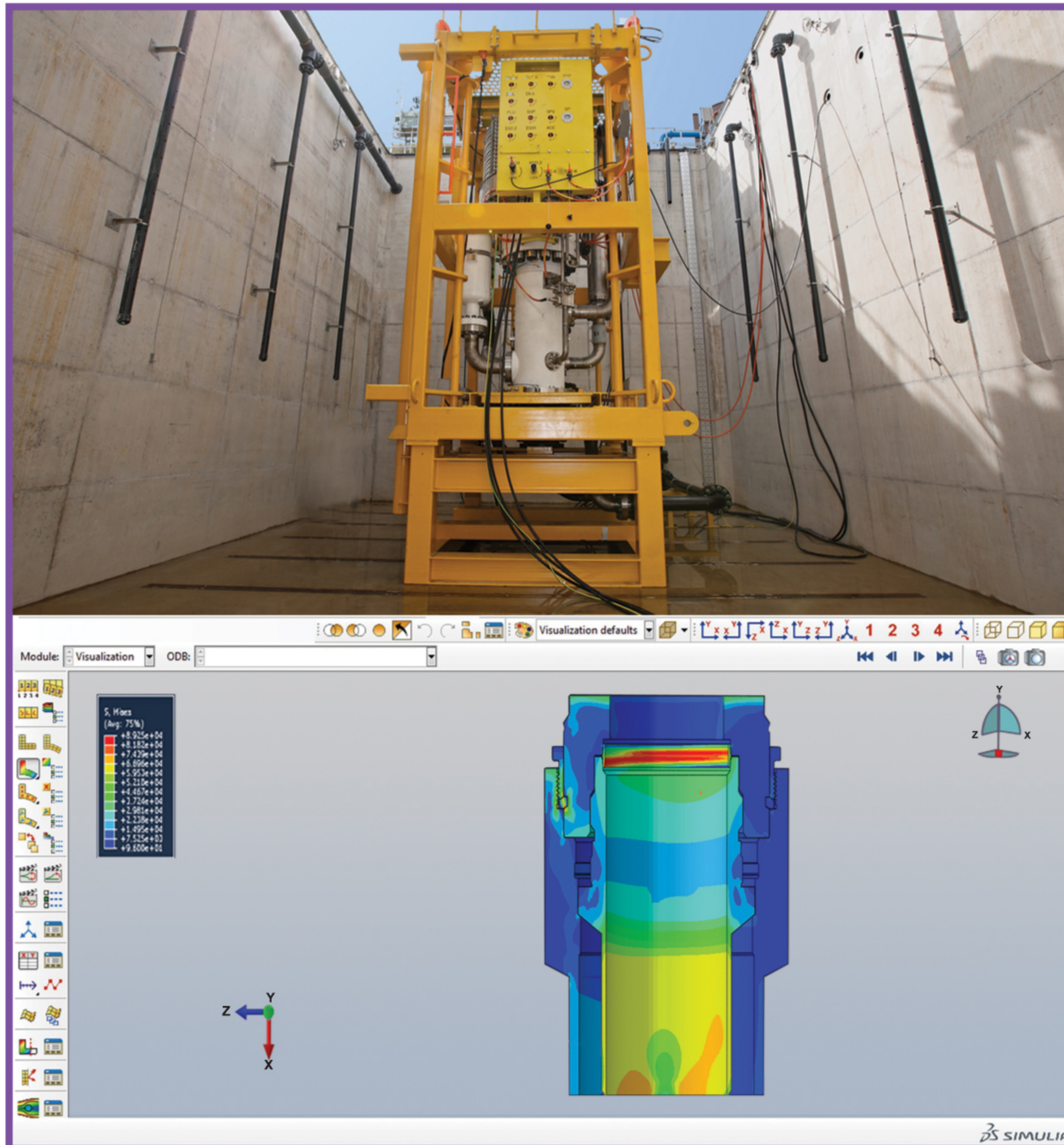

WEEK	M	T	W	T	F	S	S
14		1	2	3	4	5	6
15	7	8	9	10	11	12	13
16	14	15	16	17	18	19	20
17	21	22	23	24	25	26	27
18	28	29	30				

March						
M	T	W	T	F	S	S
31					1	2
3	4	5	6	7	8	9
10	11	12	13	14	15	16
17	18	19	20	21	22	23
24	25	26	27	28	29	30

May						
M	T	W	T	F	S	S
			1	2	3	4
5	6	7	8	9	10	11
12	13	14	15	16	17	18
19	20	21	22	23	24	25
26	27	28	29	30	31	

“Conducting complex multiphysics and hydrodynamic analysis on structures with high nonlinearity is easier in ABAQUS.”

May 2014

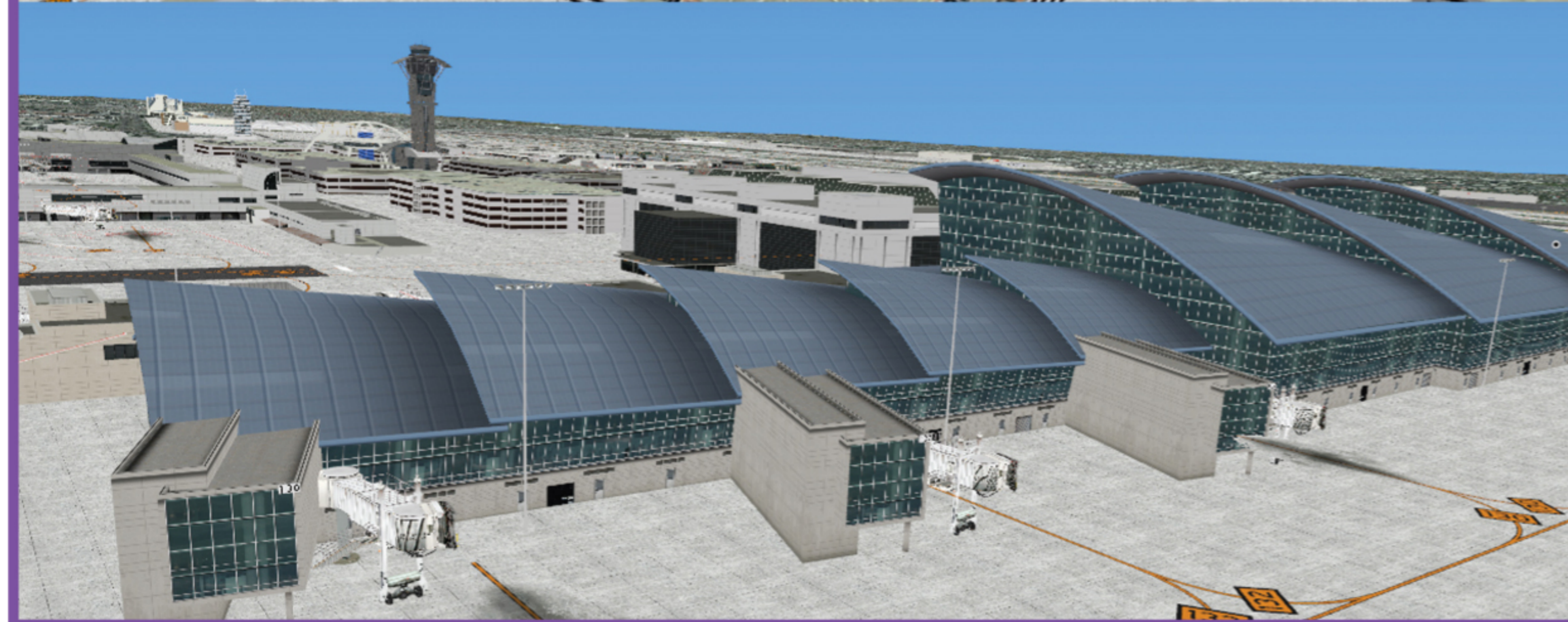

WEEK	M	T	W	T	F	S	S
18				1	2	3	4
19	5	6	7	8	9	10	11
20	12	13	14	15	16	17	18
21	19	20	21	22	23	24	25
22	26	27	28	29	30	31	

April						
M	T	W	T	F	S	S
	1	2	3	4	5	6
7	8	9	10	11	12	13
14	15	16	17	18	19	20
21	22	23	24	25	26	27
28	29	30				

June						
M	T	W	T	F	S	S
30						1
2	3	4	5	6	7	8
9	10	11	12	13	14	15
16	17	18	19	20	21	22
23	24	25	26	27	28	29

"The seamless integration between **Creator** generated 3D models and **Terra Vista** have enabled us to generate an efficient and optimized terrain."

June 2014

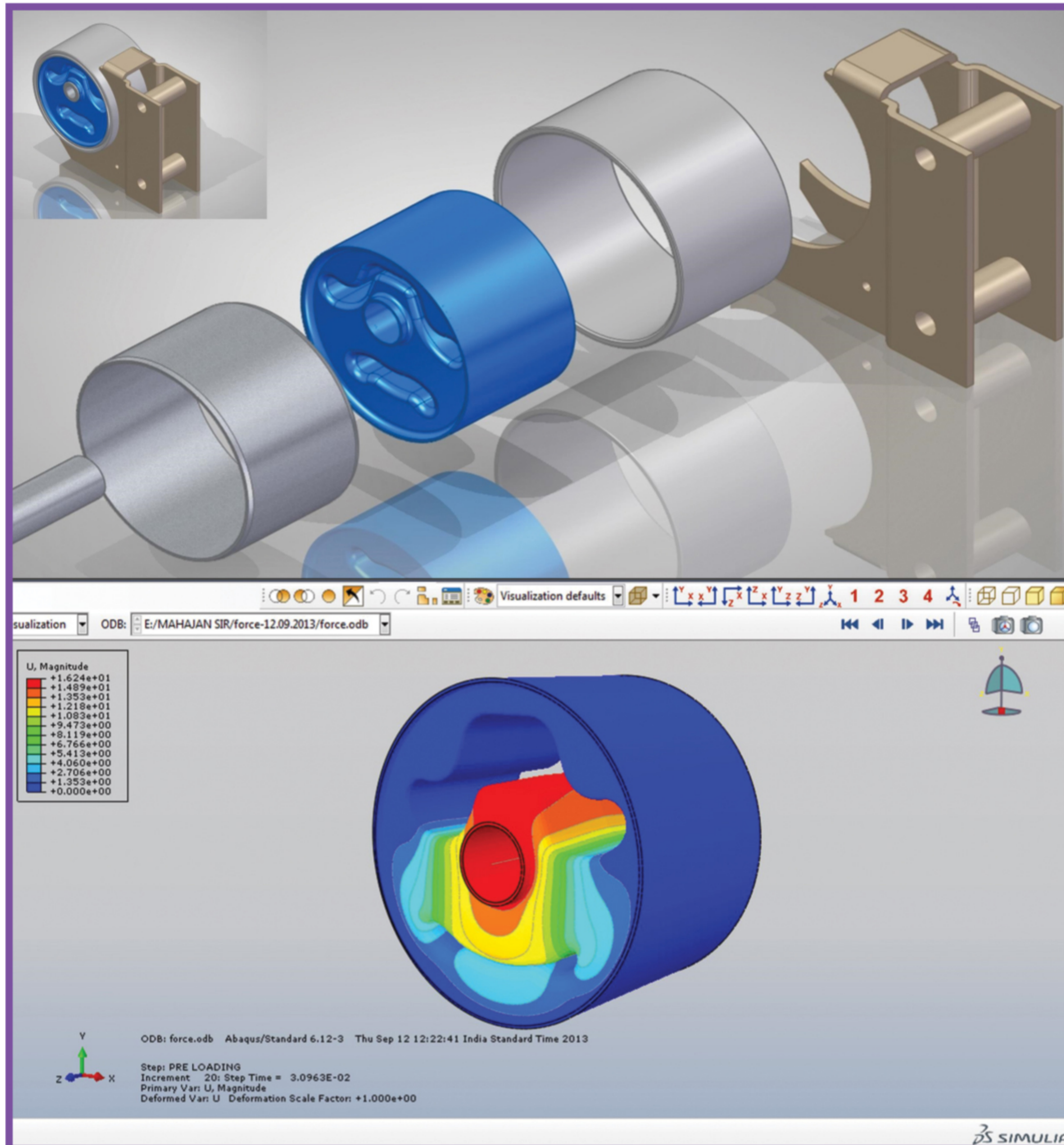

"We are using ABAQUS to solve nonlinear behavioural problems of Rubber Moulded Components."

Innova Rubbers Pvt. Ltd.

WEEK	M	T	W	T	F	S	S
22	30						1
23	2	3	4	5	6	7	8
24	9	10	11	12	13	14	15
25	16	17	18	19	20	21	22
26	23	24	25	26	27	28	29

May						
M	T	W	T	F	S	S
			1	2	3	4
5	6	7	8	9	10	11
12	13	14	15	16	17	18
19	20	21	22	23	24	25
26	27	28	29	30	31	

July						
M	T	W	T	F	S	S
	1	2	3	4	5	6
7	8	9	10	11	12	13
14	15	16	17	18	19	20
21	22	23	24	25	26	27
28	29	30	31			

July 2014

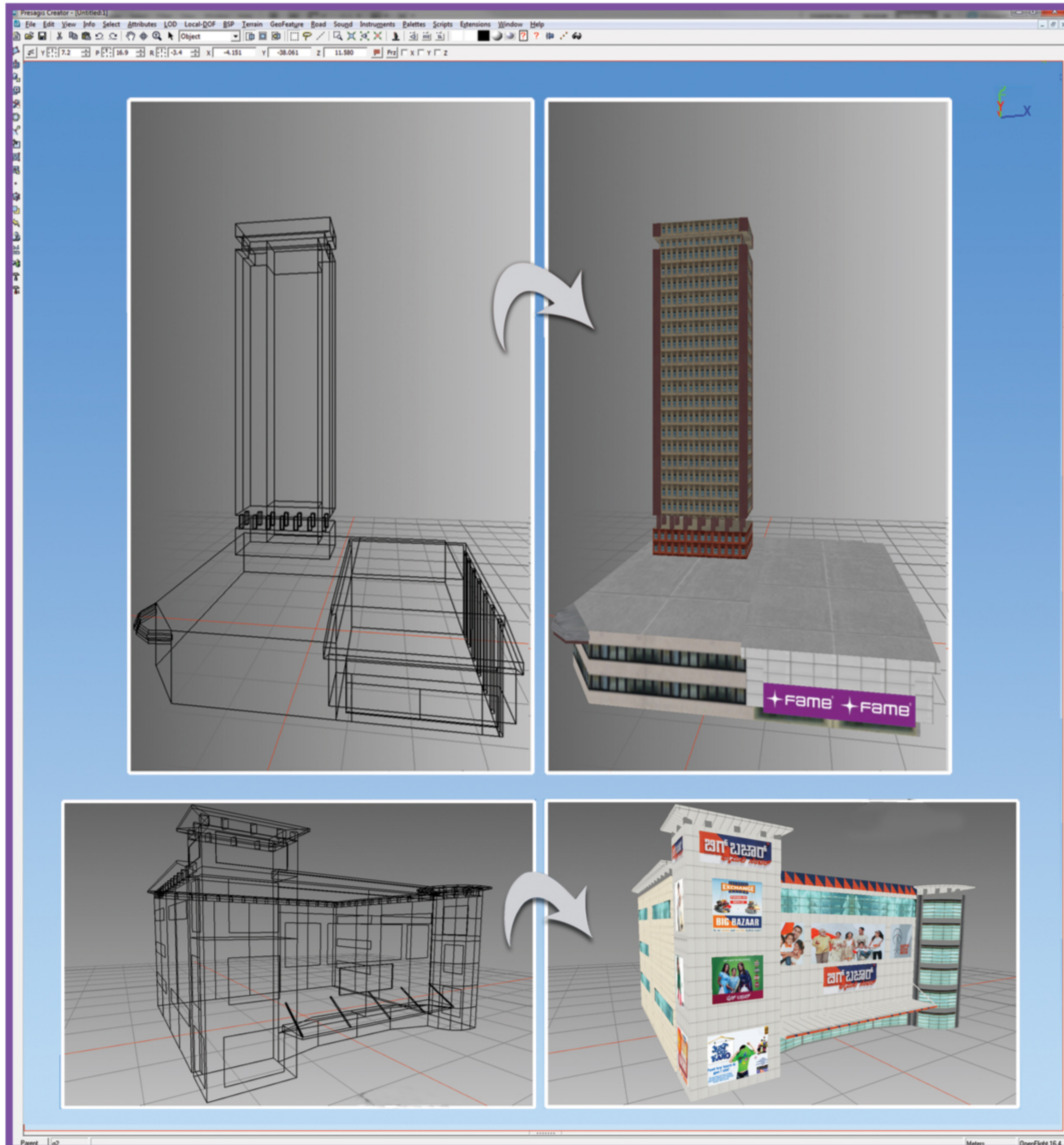

WEEK	M	T	W	T	F	S	S
27		1	2	3	4	5	6
28	7	8	9	10	11	12	13
29	14	15	16	17	18	19	20
30	21	22	23	24	25	26	27
31	28	29	30	31			

June						
M	T	W	T	F	S	S
30						1
2	3	4	5	6	7	8
9	10	11	12	13	14	15
16	17	18	19	20	21	22
23	24	25	26	27	28	29

August						
M	T	W	T	F	S	S
				1	2	3
4	5	6	7	8	9	10
11	12	13	14	15	16	17
18	19	20	21	22	23	24
25	26	27	28	29	30	31

“Creator is a user friendly tool for creating 3D synthetic environments in real time. Its modeling and texturing features has enabled us to create 3D visual database rapidly.”

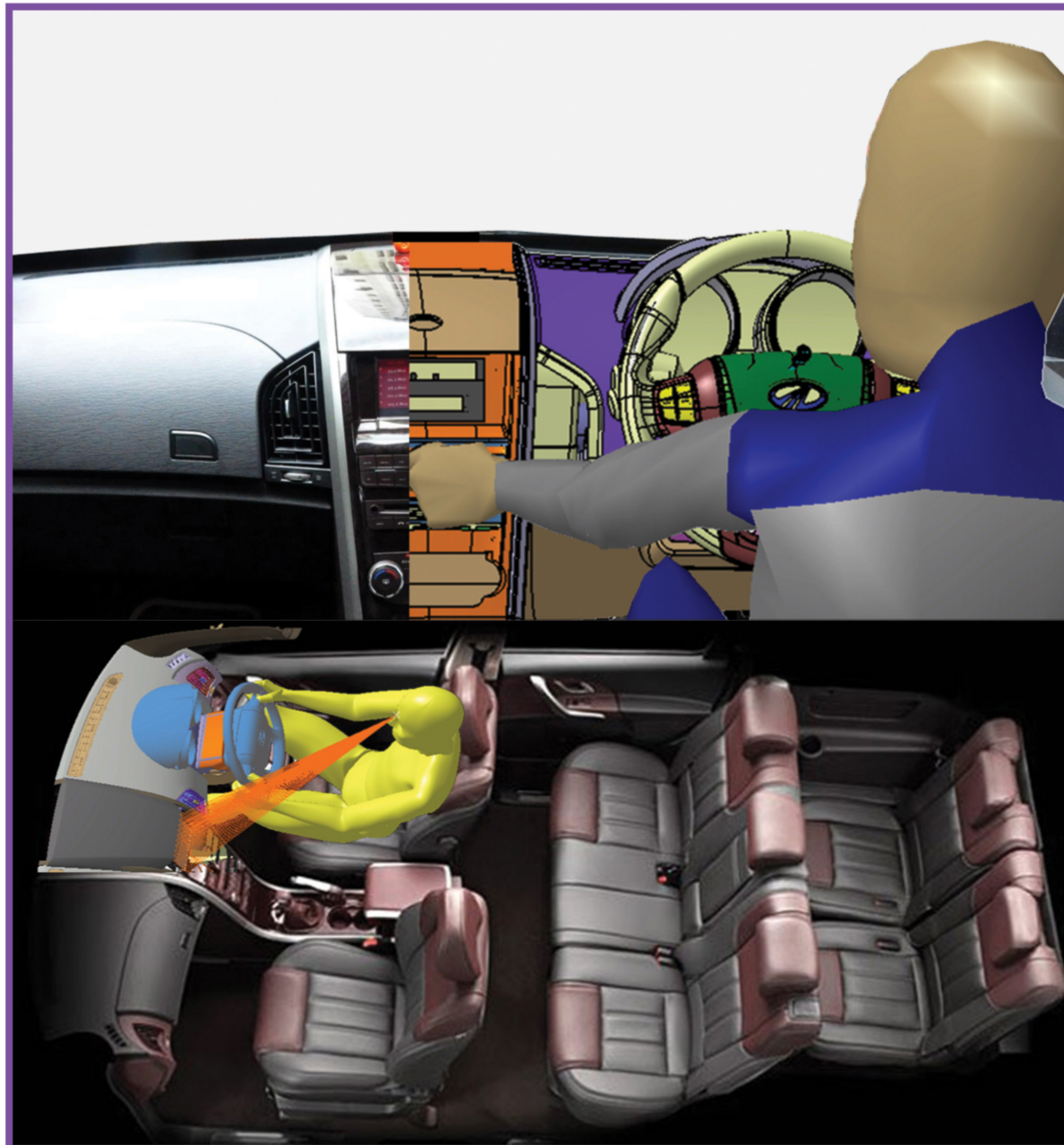

“RAMSIS has helped us to generate the occupants and evaluate driver discomfort quicker during product conceptualization. SPEOS has helped us to emulate, in-car optical reflection and glare upfront as seen in real world scenario.”

Mahindra & Mahindra Limited

August 2014

WEEK	M	T	W	T	F	S	S
31					1	2	3
32	4	5	6	7	8	9	10
33	11	12	13	14	15	16	17
34	18	19	20	21	22	23	24
35	25	26	27	28	29	30	31

July						
M	T	W	T	F	S	S
	1	2	3	4	5	6
7	8	9	10	11	12	13
14	15	16	17	18	19	20
21	22	23	24	25	26	27
28	29	30	31			

September						
M	T	W	T	F	S	S
1	2	3	4	5	6	7
8	9	10	11	12	13	14
15	16	17	18	19	20	21
22	23	24	25	26	27	28
29	30					

September 2014

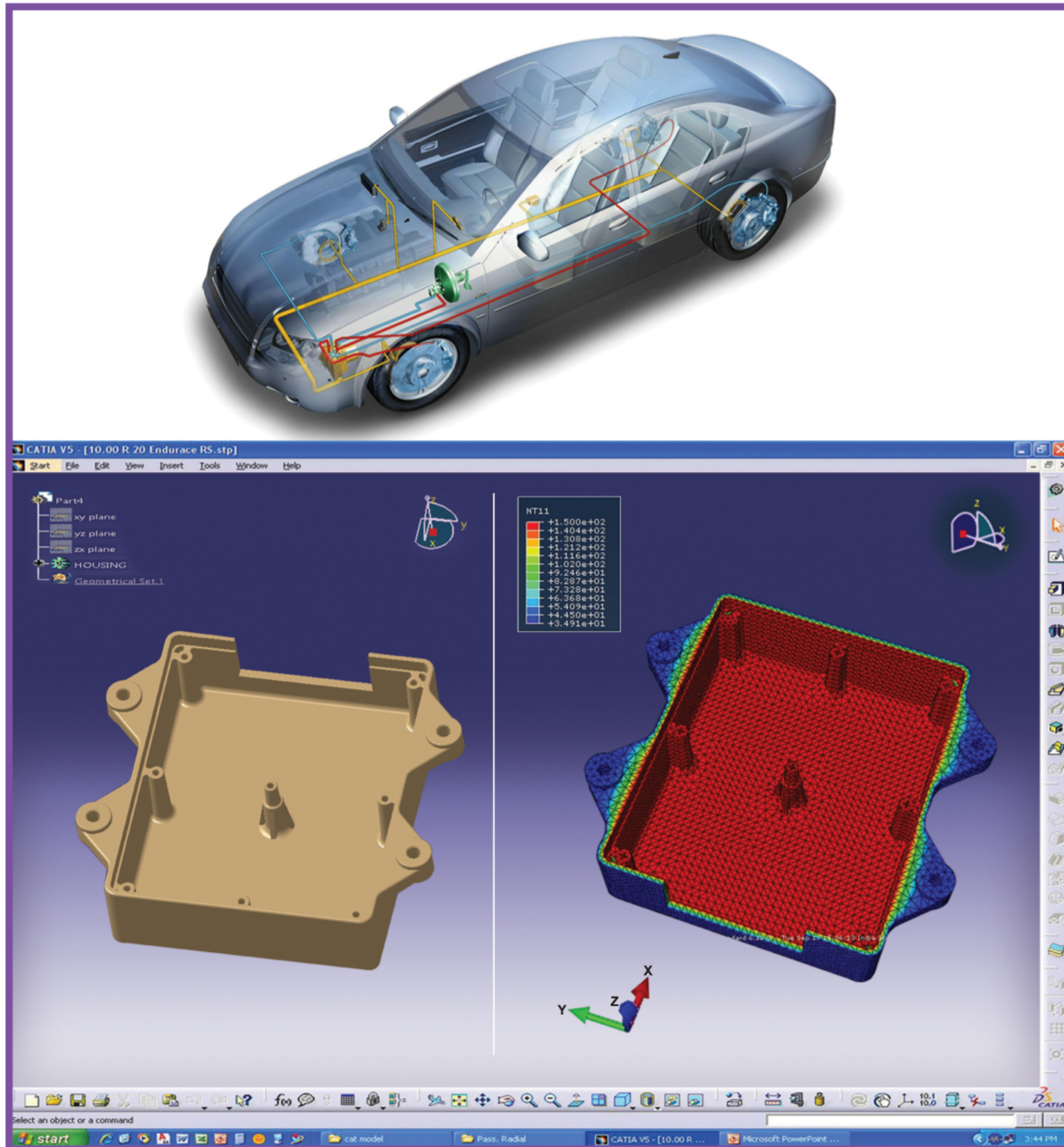

WEEK	M	T	W	T	F	S	S
36	1	2	3	4	5	6	7
37	8	9	10	11	12	13	14
38	15	16	17	18	19	20	21
39	22	23	24	25	26	27	28
40	29	30					

August						
M	T	W	T	F	S	S
				1	2	3
4	5	6	7	8	9	10
11	12	13	14	15	16	17
18	19	20	21	22	23	24
25	26	27	28	29	30	31

October						
M	T	W	T	F	S	S
		1	2	3	4	5
6	7	8	9	10	11	12
13	14	15	16	17	18	19
20	21	22	23	24	25	26
27	28	29	30	31		

“CATIA provides quick and flexible modeling environment whereas ABAQUS helps us in analyzing thermal and structural problems in Engine Control Unit.”

October 2014

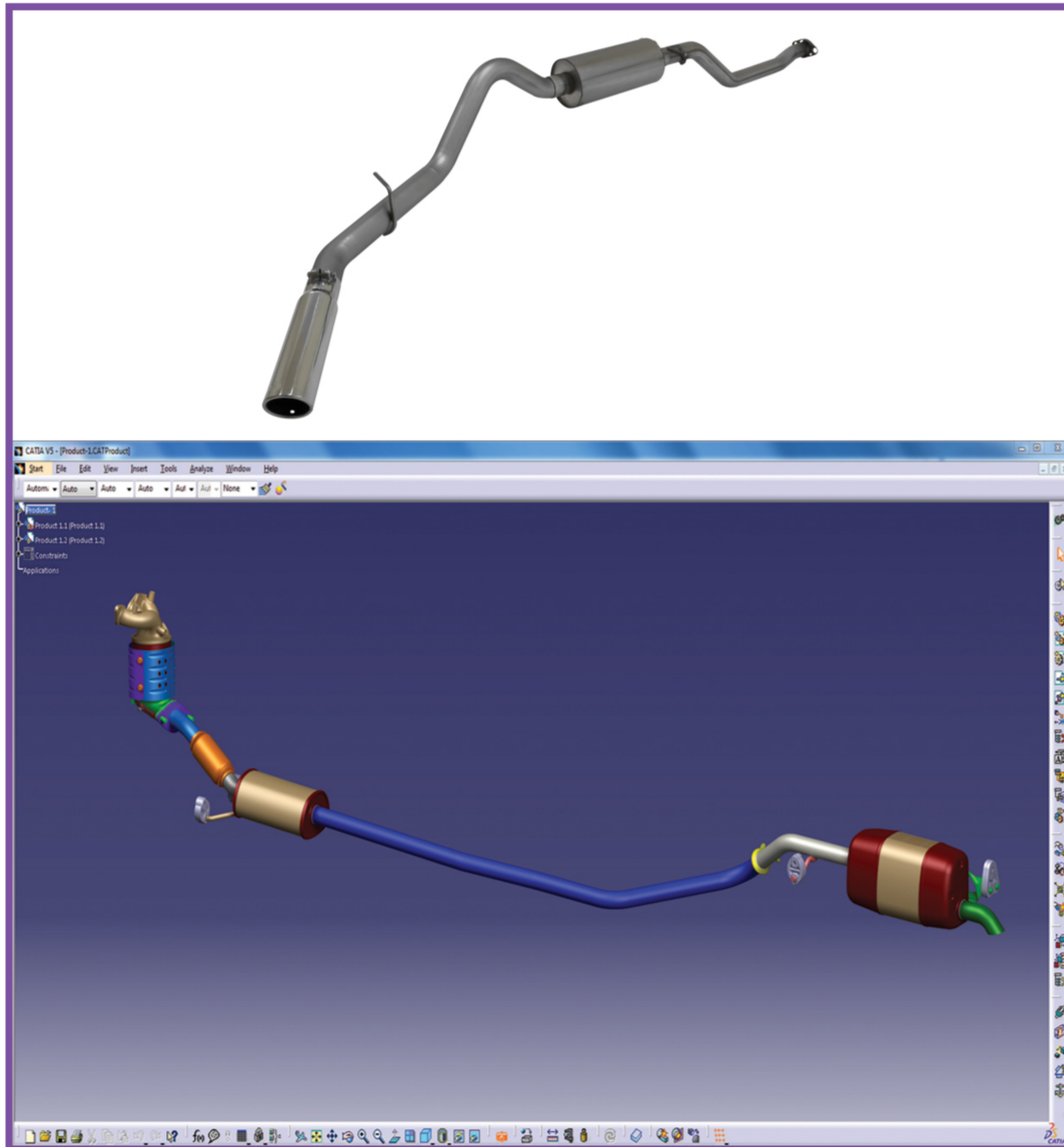

WEEK	M	T	W	T	F	S	S
40			1	2	3	4	5
41	6	7	8	9	10	11	12
42	13	14	15	16	17	18	19
43	20	21	22	23	24	25	26
44	27	28	29	30	31		

September						
M	T	W	T	F	S	S
1	2	3	4	5	6	7
8	9	10	11	12	13	14
15	16	17	18	19	20	21
22	23	24	25	26	27	28
29	30					

November						
M	T	W	T	F	S	S
					1	2
3	4	5	6	7	8	9
10	11	12	13	14	15	16
17	18	19	20	21	22	23
24	25	26	27	28	29	30

"CATIA is a user friendly tool for developing complex geometry quickly."

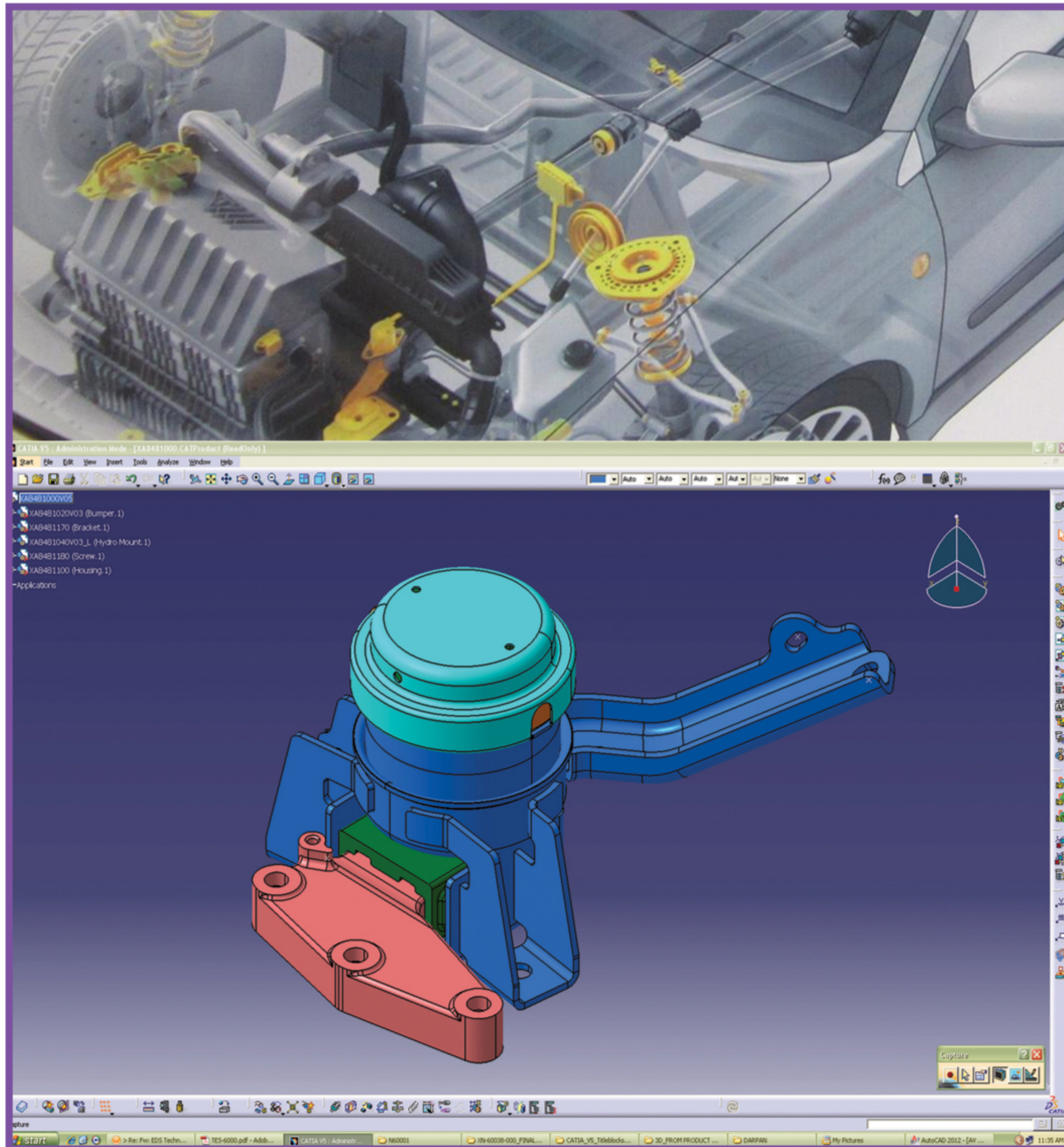

“CATIA is our global design platform for optimizing our products design.”

Trelleborg Automotive (India) Pvt. Ltd.
A company of the Trelleborg Vibracoustic Group

November 2014

WEEK	M	T	W	T	F	S	S
44						1	2
45	3	4	5	6	7	8	9
46	10	11	12	13	14	15	16
47	17	18	19	20	21	22	23
48	24	25	26	27	28	29	30

October						
M	T	W	T	F	S	S
		1	2	3	4	5
6	7	8	9	10	11	12
13	14	15	16	17	18	19
20	21	22	23	24	25	26
27	28	29	30	31		

December						
M	T	W	T	F	S	S
1	2	3	4	5	6	7
8	9	10	11	12	13	14
15	16	17	18	19	20	21
22	23	24	25	26	27	28
29	30	31				

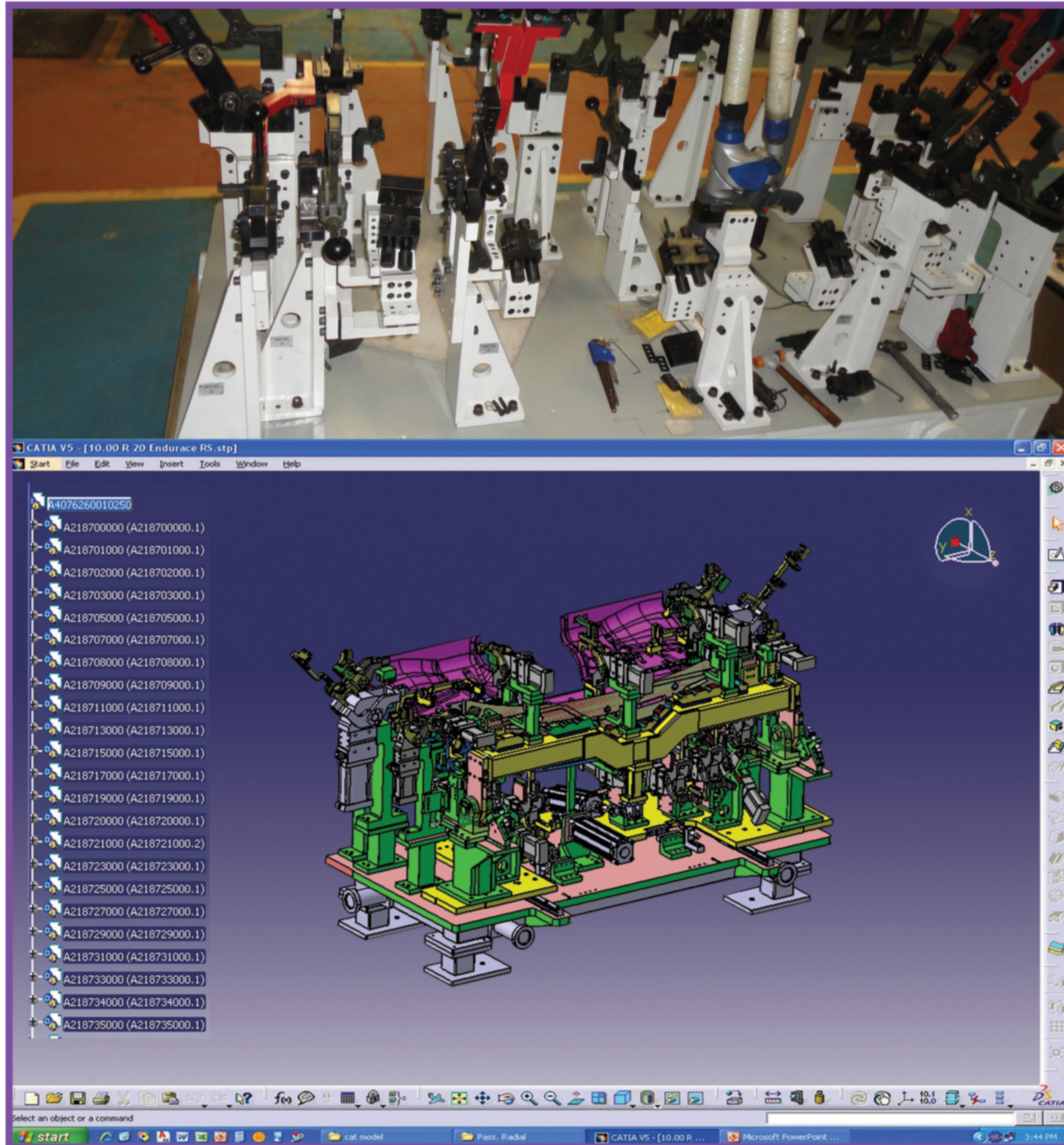

“With the implementation of CATIA solution, our design has improved Qualitatively and Quantitatively for meeting our customer demands.”

VALIANT – TMS Systems Pvt. Ltd.

December 2014

WEEK	M	T	W	T	F	S	S
49	1	2	3	4	5	6	7
50	8	9	10	11	12	13	14
51	15	16	17	18	19	20	21
52	22	23	24	25	26	27	28
53	29	30	31				

November						
M	T	W	T	F	S	S
					1	2
3	4	5	6	7	8	9
10	11	12	13	14	15	16
17	18	19	20	21	22	23
24	25	26	27	28	29	30

January						
M	T	W	T	F	S	S
			1	2	3	4
5	6	7	8	9	10	11
12	13	14	15	16	17	18
19	20	21	22	23	24	25
26	27	28	29	30	31	

INDIA S LARGEST PLM & REAL-TIME 3D VISUAL SIMULATION SOLUTIONS PROVIDER



Value Solutions



ERGONOMIC SOLUTIONS

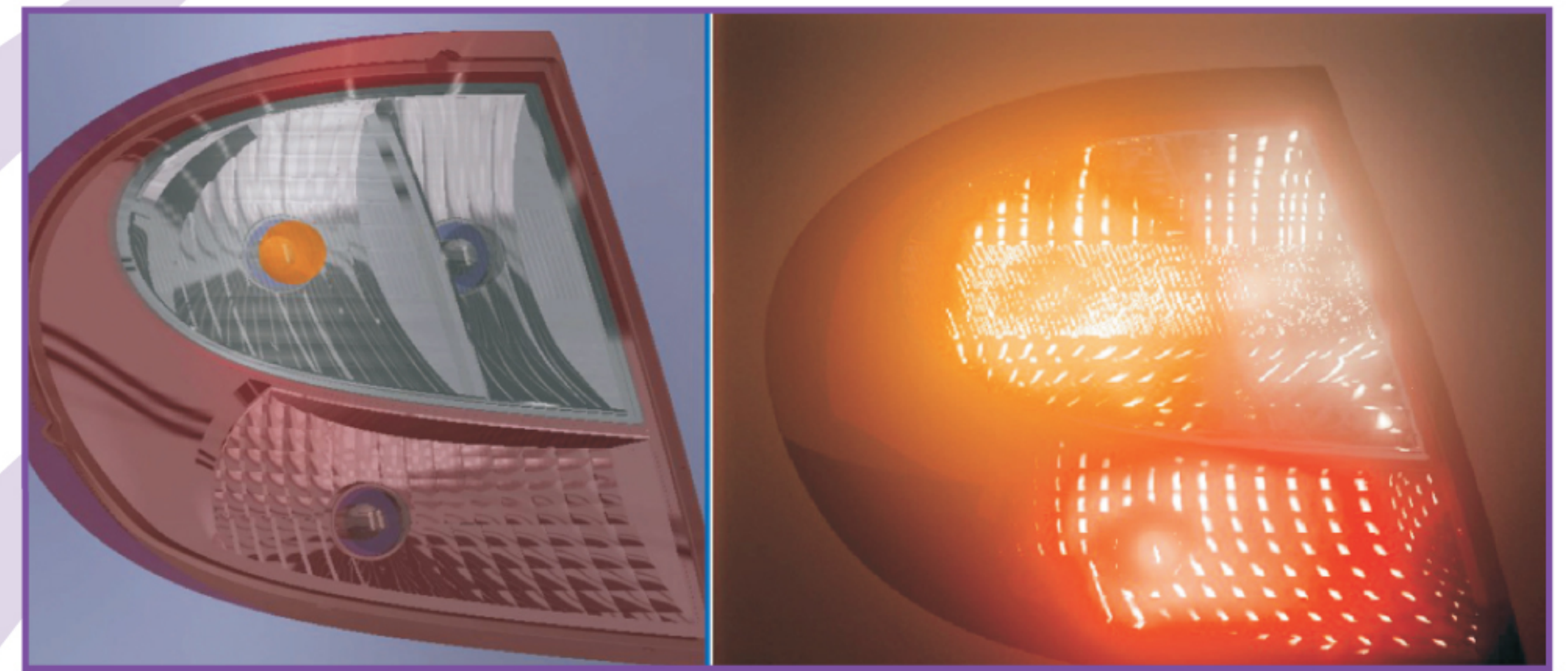

LIGHTING SIMULATION

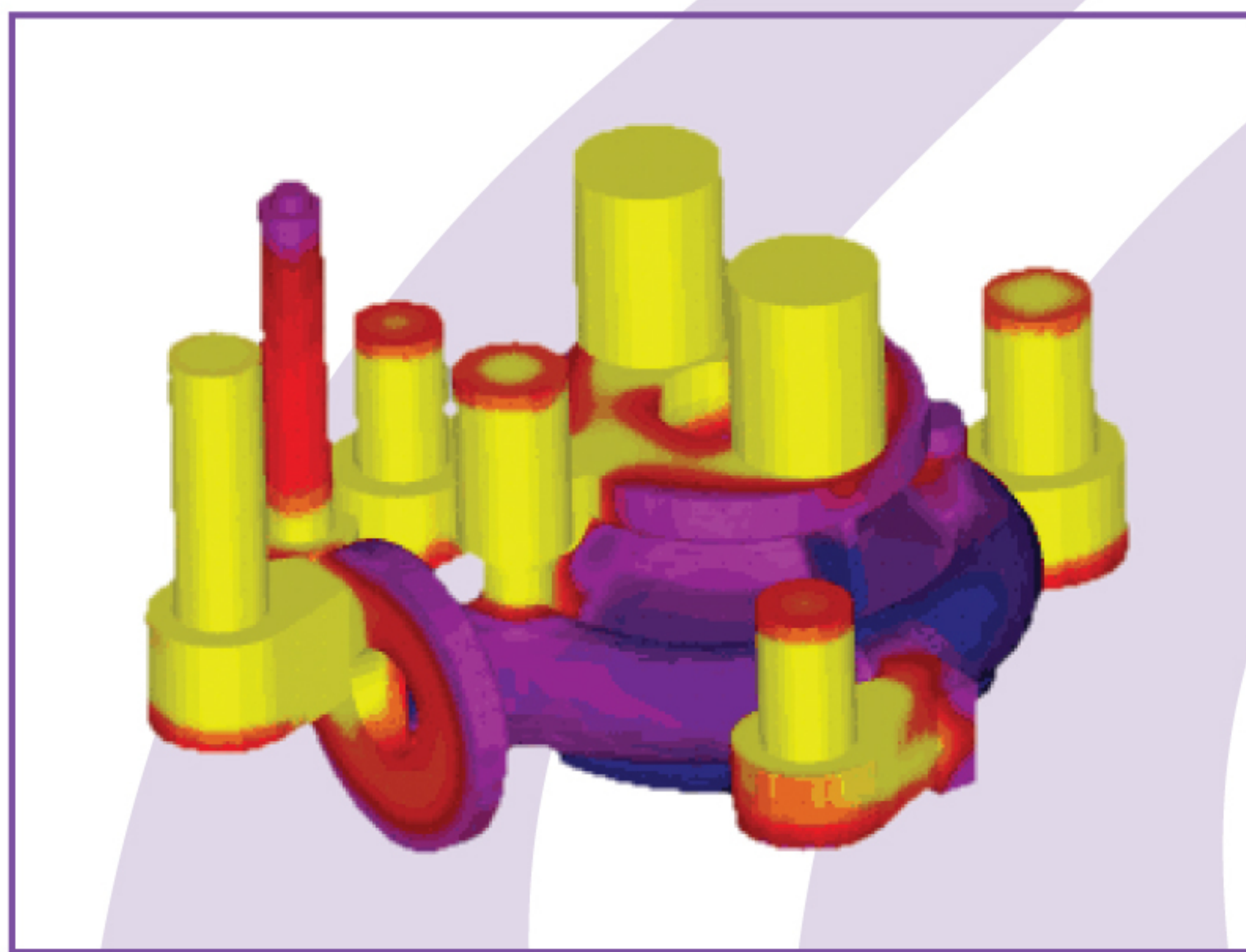

CASTING SIMULATION



INNOVATION SOLUTIONS

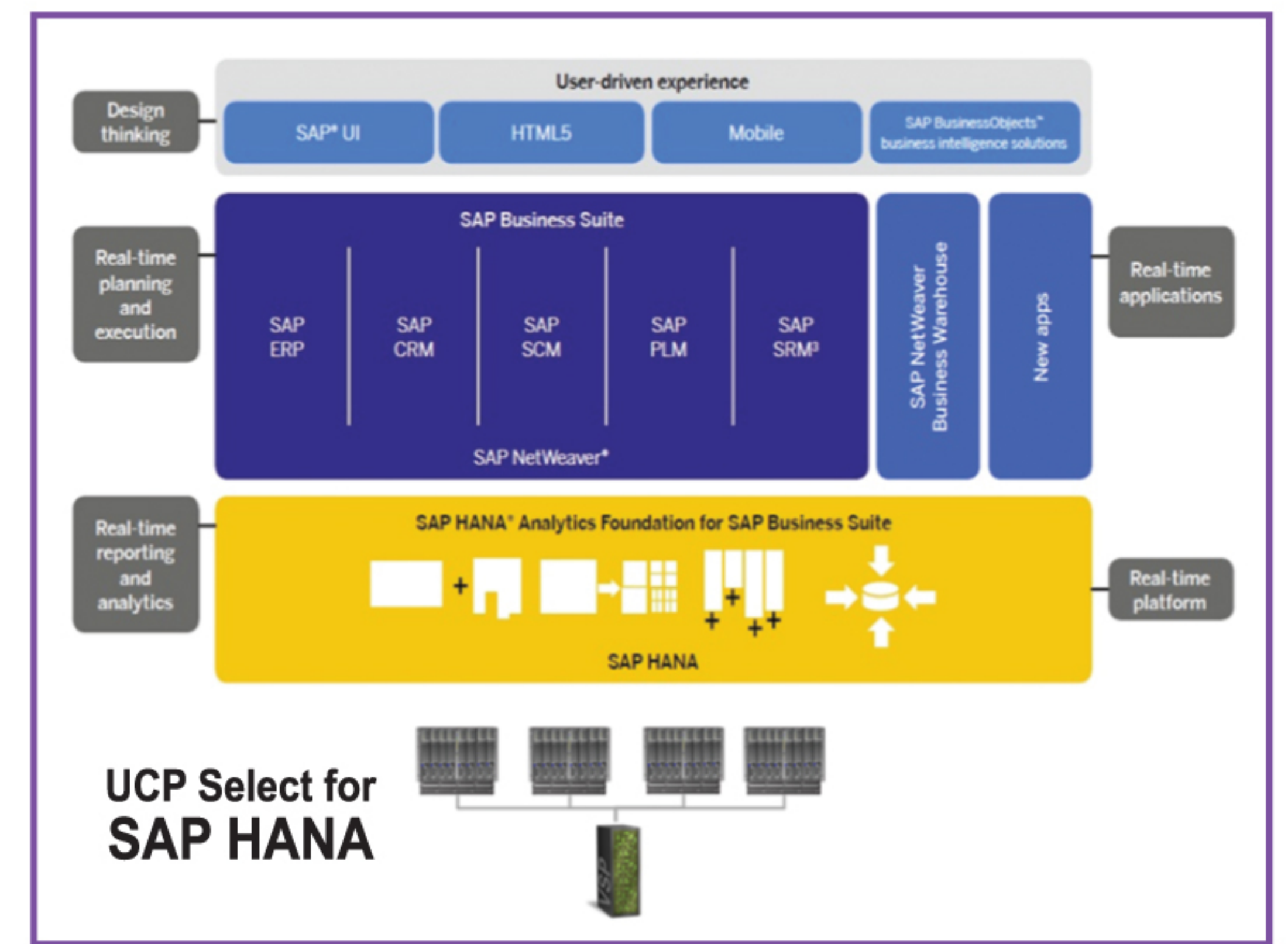

ENTERPRISE SOLUTIONS

Strategic Partners



Toll Free : 1800 425 3378

All logos are the registered trademarks of their respective companies

Bangalore (Head Office)

'The Estate', 2nd Floor
No. 121, Dickenson Road
Bangalore-560 042. INDIA
Tel: +91 (80) 49190333
Fax: +91 (80) 49190399

Chennai

2nd Floor, Plot No. B131, New No 88, 1st Avenue
Ashok Nagar, Chennai-600 083. INDIA
Tel: +91 (44) 24890253 / 0353
Fax: +91 (44) 24890214

Coimbatore

PSGCT / EDST Finishing School
TIFAC Core Building, PSG College of Technology
Peelamedu, Coimbatore-641 004. INDIA
Tel: +91 (422) 4344372
Mobile: +91 9600984883

Gurgaon

404, 4th Floor
Greenwood Plaza
Greenwood City Sec-45
Gurgaon, Haryana-122 001. INDIA
Tel: +91 (124) 4114386 - 12 Lines
Fax: +91 (124) 4114398

Ahmedabad

Apex Business Centre
4th Floor, Dev Ashish Complex
Nr. Hotel Classic Gold, Off. C.G.Road
Ahmedabad-380 009. INDIA
Tel: +91 (79) 26460267 / 68 / 69

Kochi

Govardhan Business Centre
3rd Floor, 64/898, Chittoor Road, Opposite NCC
Group HQ, Palleppady, Kochi-682 035. INDIA
Tel: +91 (484) 4047750
Mobile: +91 9995806411

Bangalore

3rd Floor, Shree Thulasi Towers, Above PAPA JOHN'S
Plot No. 672, 11th Main, 4th Block, Jayanagar
Bangalore-560 011. INDIA
Tel: +91 (80) 41120547
Mobile: +91 8861201057

Hyderabad

Unit No. 9, 5th Floor, Topaz Building
Punjagutta, Hyderabad-500 082. INDIA
Tel: +91 (40) 39106034 / 35
Fax: +91 (40) 30605260

Pune

Fourth Floor, Alpha - 2
Gigaspace, Vimannagar
Pune-411 014. INDIA
Tel: +91 (20) 41210121
Fax: +91 (20) 41210122

Mumbai

Apeejay Business Centre,
1st Floor, Apeejay Express, Vishweshwar Nagar
Plot # 87, Sector 17 Goregaon East, Vashi, Navi
Mumbai-400 703. INDIA
Tel: +91 (22) 39180610
Mobile : +91 9561022244

Kolkata

Apeejay Business Centre
Apeejay House, Block A, 8th Floor
15, Park Street, Kolkata-700 016. INDIA
Tel: +91 (33) 39845200
Mobile: +91 9831069954

Noida

First Floor, A-1, Sector -10
Noida-201 301. INDIA
Tel: +91 (120) - 4309291 / 4312909
Fax: +91 (120) - 4114398

Email: marketing@edstechnologies.com

Strategic Partners



OPTIS

TRANSCAT



PRESAGIS



HUMAN SOLUTIONS



Toll Free : 1800 425 3378

All logos are the registered trademarks of their respective companies